

General Description

The MDP9N50F uses advanced Magnachip's MOSFET Technology, which provides low on-state resistance, high switching performance and excellent quality.

MDP9N50F is suitable device for SMPS, HID and general purpose applications.

Features

- $V_{DS} = 500V$
- $I_D = 8.0A$ @ $V_{GS} = 10V$
- $R_{DS(ON)} \leq 0.9\Omega$ @ $V_{GS} = 10V$

Applications

- Power Supply
- HID
- Lighting

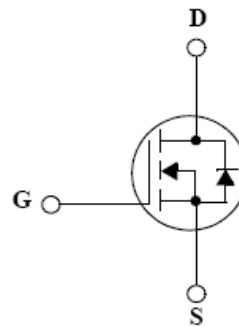

Absolute Maximum Ratings ($T_a = 25^\circ C$)

Characteristics	Symbol	Rating	Unit	
Drain-Source Voltage	V_{DSS}	500	V	
Gate-Source Voltage	V_{GSS}	± 30	V	
Continuous Drain Current	I_D	$T_C=25^\circ C$	8.0	A
		$T_C=100^\circ C$	4.8	A
Pulsed Drain Current ⁽¹⁾	I_{DM}	32	A	
Power Dissipation	P_D	$T_C=25^\circ C$	119	W
		Derate above 25 °C	0.95	W/°C
Peak Diode Recovery dv/dt ⁽³⁾	Dv/dt	4.5	V/ns	
Single Pulse Avalanche Energy ⁽⁴⁾	E_{AS}	300	mJ	
Junction and Storage Temperature Range	T_J, T_{stg}	-55~150	°C	

Thermal Characteristics

Characteristics	Symbol	Rating	Unit
Thermal Resistance, Junction-to-Ambient ⁽¹⁾	$R_{\theta JA}$	62.5	°C/W
Thermal Resistance, Junction-to-Case ⁽¹⁾	$R_{\theta JC}$	1.05	

Ordering Information

Part Number	Marking	Temp. Range	Package	Packing	RoHS Status
MDP9N50FTH	MDP9N50F	-55~150°C	TO-220	Tube	Halogen Free

Electrical Characteristics (T_a =25°C)

Characteristics	Symbol	Test Condition	Min	Typ	Max	Unit
Static Characteristics						
Drain-Source Breakdown Voltage	BV _{DSS}	I _D = 250μA, V _{GS} = 0V	500	-	-	V
Gate Threshold Voltage	V _{GS(th)}	V _{DS} = V _{GS} , I _D = 250μA	2.5	-	4.5	V
Drain Cut-Off Current	I _{DSS}	V _{DS} = 500V, V _{GS} = 0V	-	-	10	μA
Gate Leakage Current	I _{GSS}	V _{GS} = ±30V, V _{DS} = 0V	-	-	100	nA
Drain-Source ON Resistance	R _{DS(ON)}	V _{GS} = 10V, I _D = 4.0A		0.75	0.9	Ω
Forward Transconductance	g _{fs}	V _{DS} = 30V, I _D = 4.0A	-	4.2	-	S
Dynamic Characteristics						
Total Gate Charge	Q _g	V _{DS} = 400V, I _D = 8.0 A, V _{GS} = 10V ⁽³⁾	-	16.3	-	nC
Gate-Source Charge	Q _{gs}		-	5.8	-	
Gate-Drain Charge	Q _{gd}		-	6.1	-	
Input Capacitance	C _{iss}	V _{DS} = 25V, V _{GS} = 0V, f = 1.0MHz	-	781	-	pF
Reverse Transfer Capacitance	C _{rss}		-	1.83	-	
Output Capacitance	C _{oss}		-	96.1	-	
Turn-On Delay Time	t _{d(on)}	V _{GS} = 10V, V _{DS} = 250V, I _D = 8.0A, R _G = 25Ω ⁽³⁾	-	20.0	-	ns
Rise Time	t _r		-	47.5	-	
Turn-Off Delay Time	t _{d(off)}		-	28.0	-	
Fall Time	t _f		-	24.0	-	
Drain-Source Body Diode Characteristics						
Maximum Continuous Drain to Source Diode Forward Current	I _S		-	8.0	-	A
Source-Drain Diode Forward Voltage	V _{SD}	I _S = 8.0A, V _{GS} = 0V	-	-	1.4	V
Body Diode Reverse Recovery Time	t _{rr}	I _F = 8.0A, di/dt = 100A/μs ⁽³⁾	-	94.5	-	ns
Body Diode Reverse Recovery Charge	Q _{rr}		-	0.24	-	μC

Note :

1. Pulse width is based on R_{θJC} & R_{θJA} and the maximum allowed junction temperature of 150°C.
2. Pulse test: pulse width ≤300us, duty cycle≤2%, pulse width limited by junction temperature T_{J(MAX)}=150°C.
3. I_{SD} ≤8.0A, di/dt≤200A/us, V_{DD}=50V, R_G =25Ω, Starting T_J=25°C
4. L=6.5mH, I_{AS}=8.0A, V_{DD}=50V, , R_G =25Ω, Starting T_J=25°C

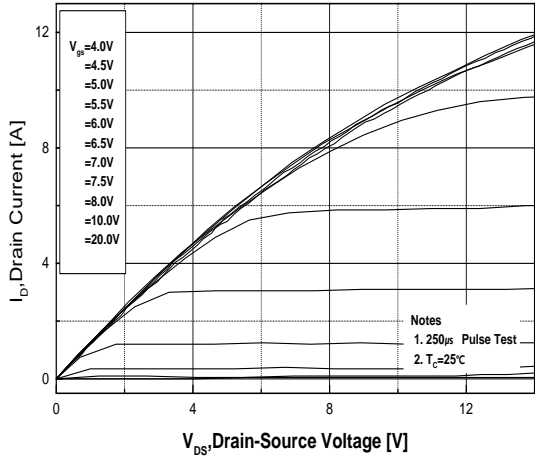

Fig.1 On-Region Characteristics

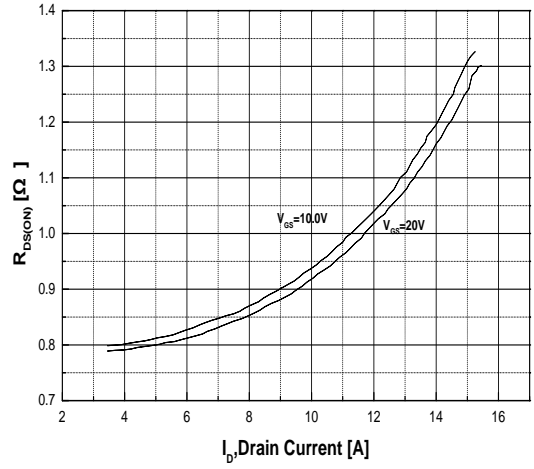

Fig.2 On-Resistance Variation with Drain Current and Gate Voltage

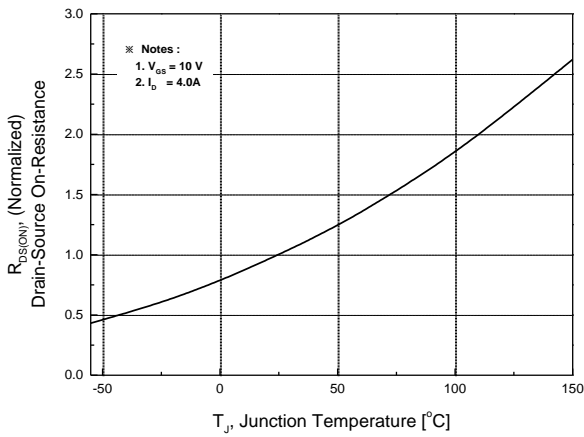

Fig.3 On-Resistance Variation with Temperature

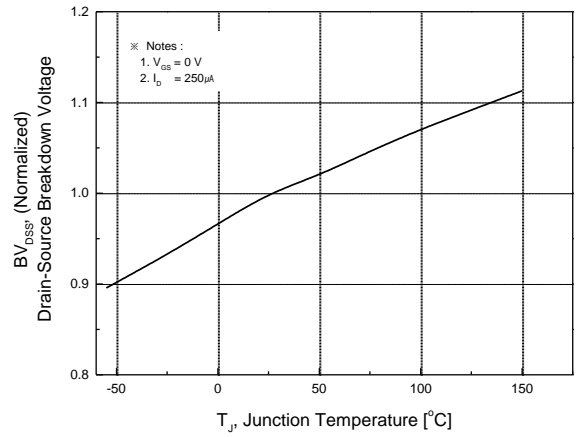

Fig.4 Breakdown Voltage Variation vs. Temperature

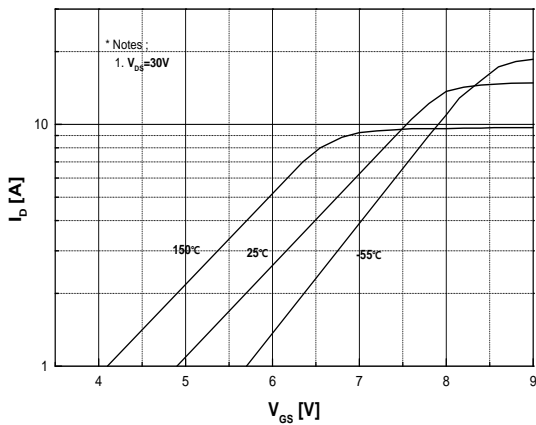

Fig.5 Transfer Characteristics

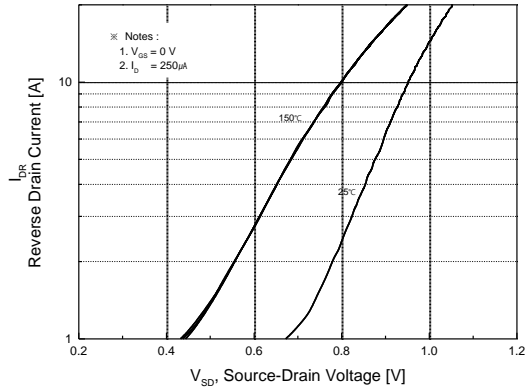

Fig.6 Body Diode Forward Voltage Variation with Source Current and Temperature

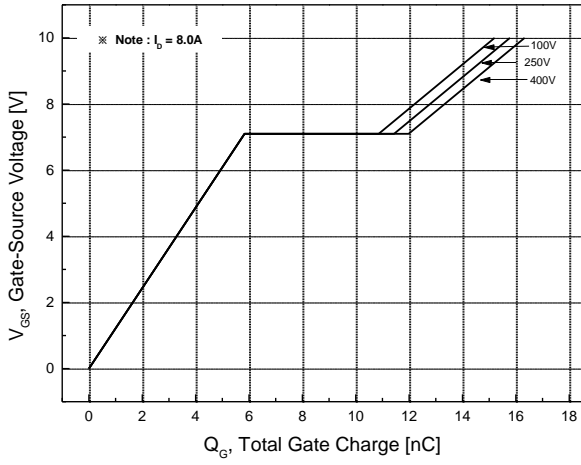

Fig.7 Gate Charge Characteristics

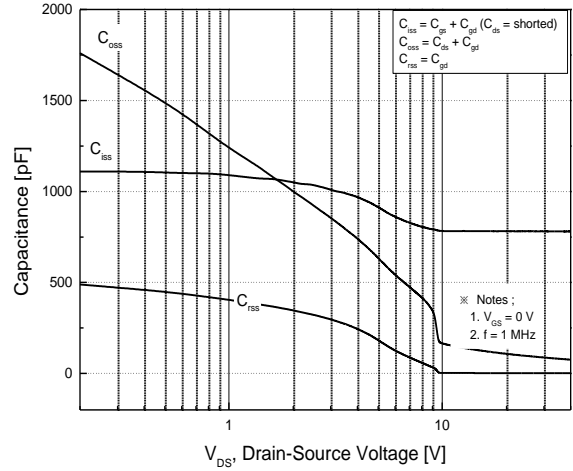

Fig.8 Capacitance Characteristics

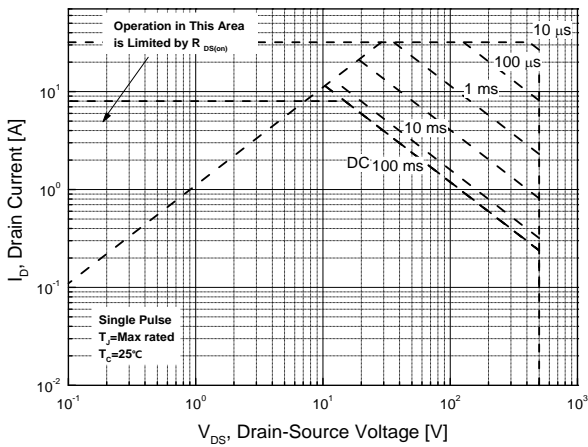

Fig.9 Maximum Safe Operating Area

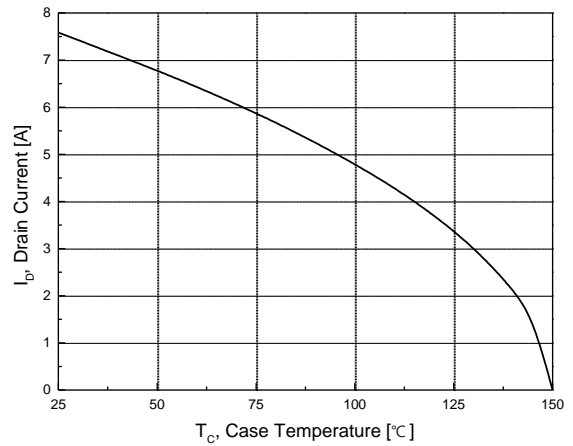

Fig.10 Maximum Drain Current vs. Case Temperature

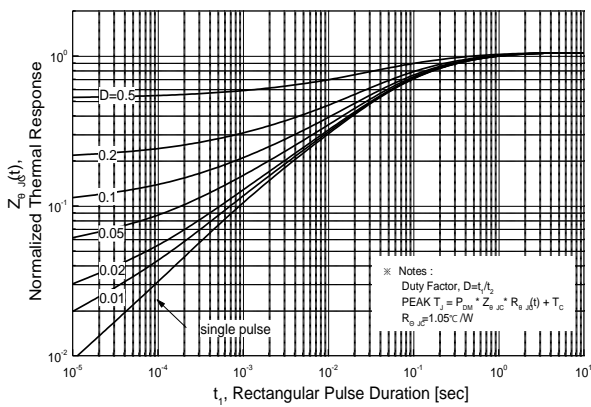

Fig.11 Transient Thermal Response Curve

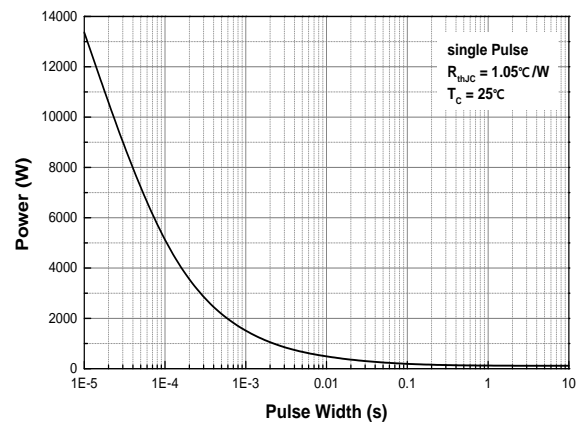
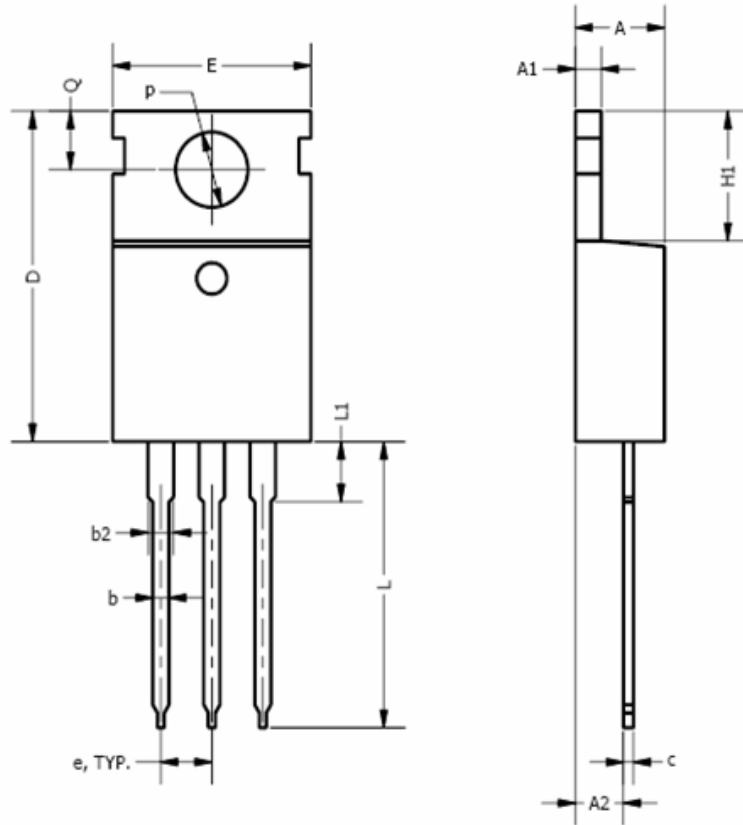

Fig.12 Single Pulse Maximum Power Dissipation

Physical Dimensions

TO-220

Dimensions are in millimeters unless otherwise specified



Symbol	Min	Nom	Max
A	3.56		4.83
A1	0.50		1.40
A2	2.03		2.92
b	0.38	0.69	1.02
b2	1.14	1.45	1.78
c	0.36		0.61
D	14.22		16.51
e	2.54 TYP		
E	9.65		10.67
H1	5.84		6.86
L	12.70		14.73
L1			6.35
φP	3.53		4.09
Q	2.54		3.43

DISCLAIMER:

The Products are not designed for use in hostile environments, including, without limitation, aircraft, nuclear power generation, medical appliances, and devices or systems in which malfunction of any Product can reasonably be expected to result in a personal injury. Seller's customers using or selling Seller's products for use in such applications do so at their own risk and agree to fully defend and indemnify Seller.

Magnachip reserves the right to change the specifications and circuitry without notice at any time. Magnachip does not consider responsibility for use of any circuitry other than circuitry entirely included in a Magnachip product.  Magnachip is a registered trademark of Magnachip Semiconductor Ltd.