

# Datasheet - MAP3249

## 4-channel LED Driver for High Brightness LEDs

### General Description

MAP3249 is a 4-channel LED driver optimized for LED backlight application targeting mid and large size LCD module. MAP3249 uses the boost MOSFET externally and 4-channel current sources internally for driving high brightness White LEDs.

MAP3249 has 60V absolute Max. rating FB pins and input voltage is ranged from 8.5V ~ 28V and max LED current is 200mA per channel.

MAP3249 has internal soft-start and various protections like output over-voltage, LED short/open, open schottky diode, UVLO and thermal shutdown.

MAP3249 has an unused channel detection function to not boost the output voltage to OVP at start-up.

MAP3249 is available 16 leads SOIC with Halogen-free (fully RoHS compliant).



### Features

- 8.5V to 28V Input Voltage Range
- Drive up to 4 Channels
- 60V FB Pin Voltage
- 0.4V Headroom Voltage
- 200mA Output Current per Channel
- Programmable Boost Switching Frequency (100KHz ~ 500KHz)
- LED Current Set by both PWM and External DC Voltage
- Unused Channel Detection
- Boost Over Current Protection
- Output Over Voltage Protection
- LED Short / Open Protection
- Schottky Diode Open Protection
- UVLO

### Applications

- High Brightness white LED backlighting for LCD TVs and monitors
- General LED lighting applications

### Ordering Information

Part Number	Top Marking	Ambient Temperature Range	Package	RoHS Status
MAP3249SIRH	MAP3249	-40°C to +85°C	16Leads SOIC	Halogen Free

### Typical Application

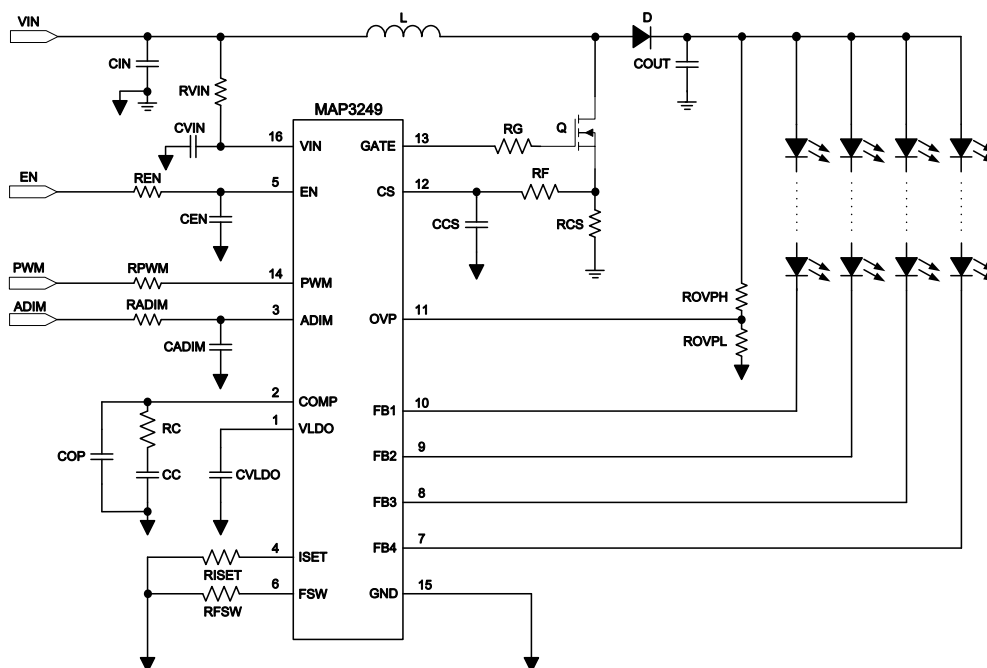

### Pin Configuration

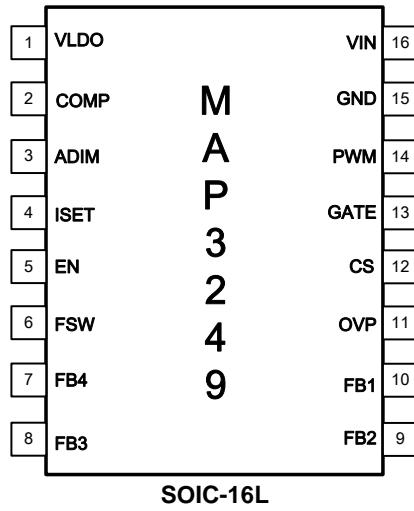

### Functional Block Diagram

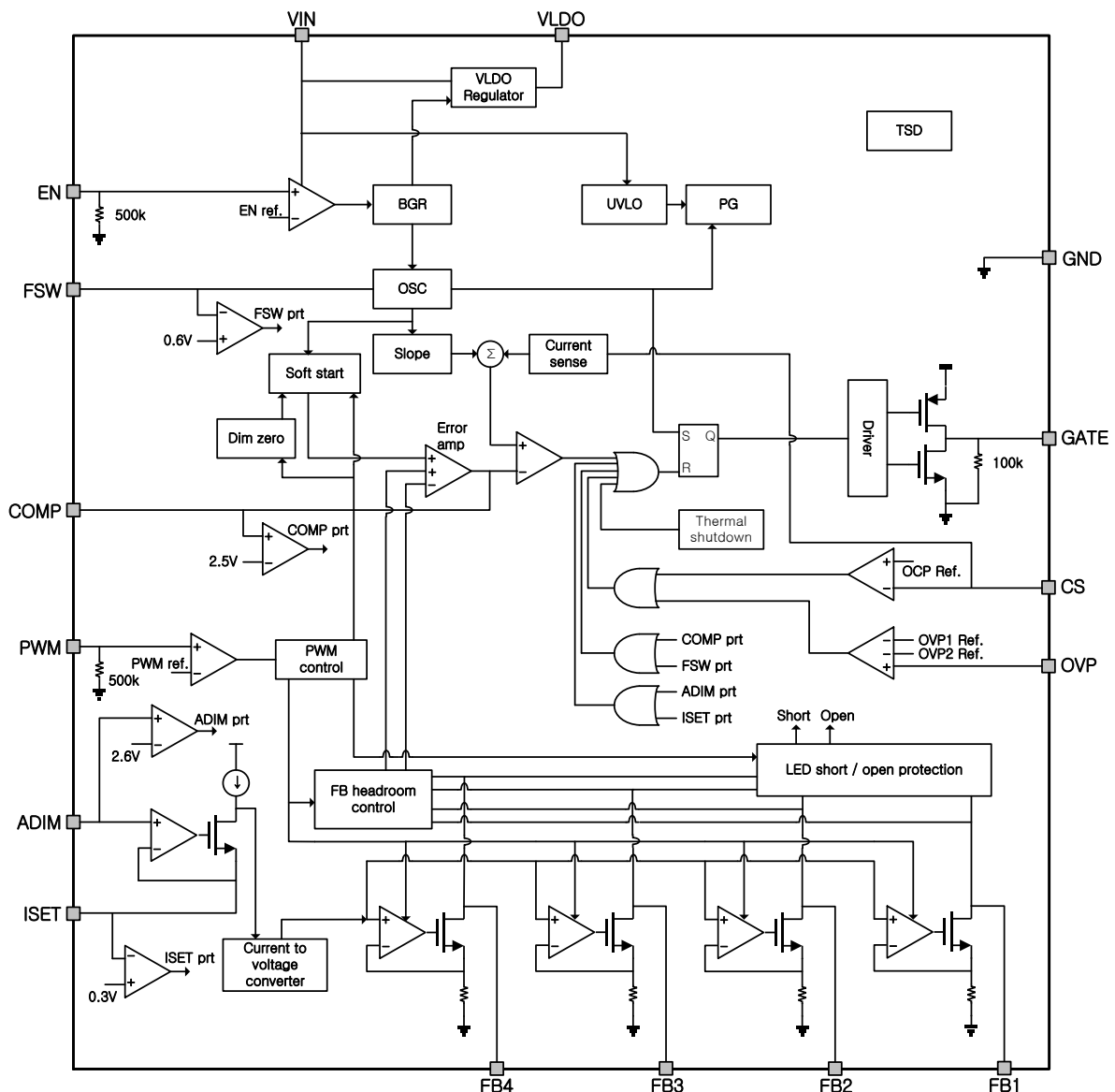

## Pin Description

16leads SOIC	Name	Description
1	VLDO	Internal 5.2V Regulator Output. Need external capacitor to stabilize.
2	COMP	Internal error amplifier compensation (Note 1)
3	ADIM	Setting for LED current thru external DC voltage
4	ISET	Setting for LED current reference resistor (Note2)
5	EN	Enable. Active High.
6	FSW	Setting for booster switching frequency (Note 3)
7	FB4	LED current sink for Ch4 (Note 4)
8	FB3	LED current sink for Ch3 (Note 4)
9	FB2	LED current sink for Ch2 (Note 4)
10	FB1	LED current sink for Ch1 (Note 4)
11	OVP	Output Over voltage sense (Note 5)
12	CS	External boost current sense (Note 6)
13	GATE	Gate driver output for external boost MOSFET
14	PWM	PWM signal input for dimming (Note 7)
15	GND	Ground
16	VIN	Power supply input. Need external bypass capacitor.

**Note 1:** Connect external capacitor and resistor to COMP pin. Refer to typical application diagram

**Note 2:** The resistor value on ISET pin controls the full scale level of sink current on FB- pins. Do not leave this pin open.

**Note 3:** Connect external resistor to set the oscillator frequency from 100kHz to 500kHz

**Note 4:** If not used, connect to GND.

**Note 5:** Connect center node of resistive voltage divider from output to ground. Refer to a typical application diagram

**Note 6:** Connect external resistor to GND to sense the external power MOSFET drain current

**Note 7:** This external PWM signal is used for brightness control

### Absolute Maximum Ratings <sup>(Note 1)</sup>

Symbol	Parameter	Min	Max	Unit
$V_{VIN}$	Supply Voltage	-0.3	30	V
$V_{EN}, V_{CS}, V_{VLDO}, V_{PWM}, V_{COMP}, V_{OVP}, V_{GATE}, V_{ISET}, V_{FSW}, V_{ADIM}$	EN, CS, VLDO, PWM, COMP, OVP, GATE, ISET, FSW, ADIM pins	-0.3	6	V
$V_{FB1-4}$	FB1 ~ FB4 pins	-0.3	60	V
$I_{FB1-4}$	FB1 ~ FB4 pins		200	mA
$T_{PAD}$	Soldering Lead/ Pad Temperature 10sec		300	°C
$T_J$	Junction Temperature	-40	+150	°C
$T_S$	Storage Temperature	-65	+150	°C
ESD	HBM on All Pins (Note 2)	-2000	+2000	V
	MM on All Pins (Note 3)	-200	+200	

**Note 1:** Stresses beyond the above listed maximum ratings may damage the device permanently. Operating above the recommended conditions for extended time may stress the device and affect device reliability. Also the device may not operate normally above the recommended operating conditions. These are stress ratings only.

**Note 2:** ESD tested per JESD22A-114.

**Note 3:** ESD tested per JESD22A-115.

### Recommended Operating Conditions <sup>(Note 1)</sup>

Symbol	Parameter	Min	Max	Unit
$V_{VIN}$	Supply Input Voltage	8.5	28	V
$T_A$	Ambient Temperature (Note 2)	-40	+85	°C

**Note 1:** Normal operation of the device is not guaranteed if operating the device over outside range of recommended conditions.

**Note 2:** The ambient temperature may have to be derated if used in high power dissipation and poor thermal resistance conditions.

### Package Thermal Resistance <sup>(Note 1)</sup>

Symbol	Parameter	$\theta_{JA}$	$\theta_{JC}$	Unit
MAP3249SIRH	16 Leads SOIC	80	49	°C/W

**Note 1:** Multi-layer PCB based on JEDEC standard (JESD51-7)

## Electrical Characteristics

Unless noted,  $V_{VIN} = 12V$ ,  $C_{VIN} = 1.0\mu F$ , and typical values are tested at  $T_A = 25^\circ C$ .

Parameter		Test Condition	Min	Typ	Max	Unit
<b>General Input Output</b>						
$V_{VIN}$	Input Voltage Range		8.5		28	V
$I_Q$	Quiescent Current	Driving FBs at Min. setting with no load		4	10	mA
$I_{SD}$	Ground Pin Current in Shutdown	$V_{VIN} = 12V$ , $V_{EN} = 0V$ No Load Current on FB		40		$\mu A$
$V_{EN}$	Logic Input Level on EN pin	$V_{EN\_L}$ : Logic Low			0.8	V
		$V_{EN\_H}$ : Logic High	2.2			
$R_{EN}$	Pull-down resistor on EN pin		250	500		k $\Omega$
$V_{UVLO}$	Under Voltage Lockout Threshold Voltage on VIN pin	Stop threshold		6.5	7.0	V
		Start threshold		7.5	8.2	
<b>Oscillator</b>						
$f_{SW}$	Internal Oscillator Frequency	$R_{FSW}=250\text{ k}\Omega$	180	200	220	kHz
		$R_{FSW}=100\text{ k}\Omega$	425	500	575	
$D_{max}$	Max. Duty Cycle		85	90		%
<b>Reference</b>						
$V_{VLDO}$	LDO Voltage	$V_{VIN} \geq 8.5V$ , $0mA \leq I_{LDO} \leq 10mA$	4.95	5.2	5.45	V
<b>Protection</b>						
$T_{SD}$	Thermal Shutdown Temperature	Shutdown Temperature		150		$^\circ C$
		Hysteresis, $\Delta T_{SD}$		25		
$V_{OVP}$	Over-Voltage Threshold on OVP pin	Rising Over-Voltage Limit on OVP pin	2.35	2.5	2.65	V
		Hysteresis, $\Delta V_{OVP}$		0.1		
$V_{LED\_SHORT}$	LED Short Protection Threshold on FB pins	FB1 ~ FB4		8.5		V
$t_{SCP}$	LED Short Protection Time	$f_{SW}=500kHz$ (Note 1, 2)		8.192		ms
$V_{CS}$	Boost Over Current Protection Threshold on CS pin		0.57	0.6	0.63	V
$V_{OPEN}$	LED Open Protection Threshold on FB pins	$I_{LED}=90mA$		0.09		V
		$I_{LED}=200mA$		0.2		
$V_{SBDOPEN}$	SBD Open Protection Threshold on OVP pin			0.1		V
<b>LED Current Sink Regulator</b>						
$V_{FB1-4}$	Min. FB1~FB4 Voltage			0.4		V
$I_{FB}$	Current Accuracy	$I_{LED}=50mA$	-5.0		+5.0	%
$I_{FB\_max}$	Current Sink Max. Current	$V_{ADIM}=2.0V$		200		mA
$I_{FB\_leakage}$	Current Sink Leakage Current	$V_{PWM}=0V$ , $V_{FB}=30V$			5	$\mu A$
$V_{ADIM}$	ADIM Input Voltage Range		0.9		2.0	V
<b>PWM Interface</b>						
$f_{PWM}$	PWM Dimming Frequency		0.1		2.0	kHz
$V_{PWM}$	Logic Input Level on PWM pin	$V_{PWM\_L}$ : Logic Low			0.8	V
		$V_{PWM\_H}$ : Logic High	2.2			
$t_{ON\_MIN}$	Min. On-Time (Note 1)	$f_{SW}=200kHz$		7		$\mu s$
$R_{PWM}$	Pull-down Resistor on PWM pin		250	500		k $\Omega$
<b>Boost MOSFET GATE Driver</b>						
$V_{GATE}$	GATE Drive Voltage	$V_{VIN} \geq 8.5V$	4.95	5.2	5.45	V
$I_{SOURCE}$	GATE Source Current	$V_{VIN} \geq 8.5$ , $V_{GATE} = 0.9 * V_{VLDO}$	35			mA
$I_{SINK}$	GATE Sink Current	$V_{VIN} \geq 8.5V$ , $V_{GATE} = 0.1 * V_{VLDO}$	30			mA
$t_{RISE}$	GATE Output Rising Time	GATE load : $10\Omega / 1nF$		0.1	0.5	$\mu s$
$t_{FALL}$	GATE Output Falling Time	GATE load : $10\Omega / 1nF$		0.1	0.5	$\mu s$
<b>Soft Start</b>						
$t_{SS}$	Soft Start Time	$f_{SW}=200kHz$ (Note 1)		8.5	13.0	ms

**Note 1:** These parameters, although guaranteed by design, are not tested in mass production.

**Note 2:**  $t_{scp} = \frac{1}{f_{sw}} \times 4096$

### Typical Operating Characteristics

Unless otherwise noted,  $V_{IN} = 12V$ ,  $C_{in} = 220\mu F$ ,  $C_{out} = 100\mu F$ ,  $R_{ISET} = 5.5k\Omega$ ,  $R_{FSW} = 250k\Omega$  and  $T_A = 25^\circ C$ .

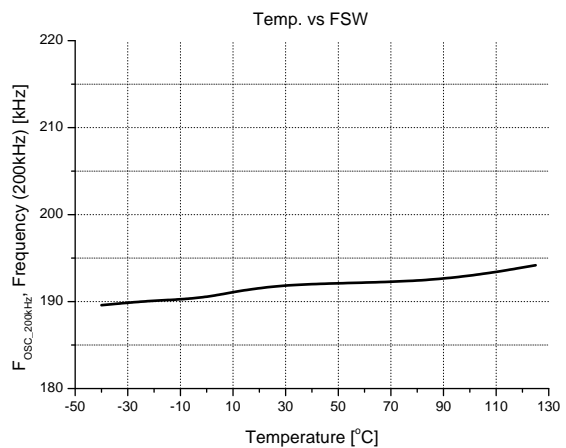
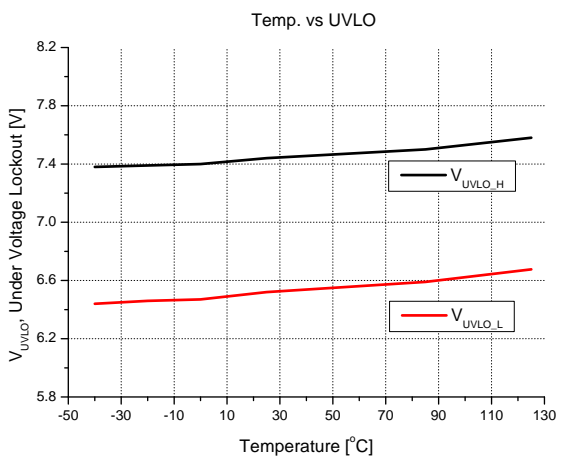
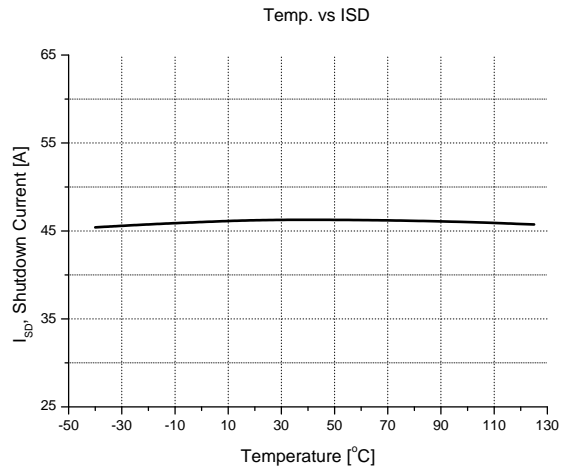
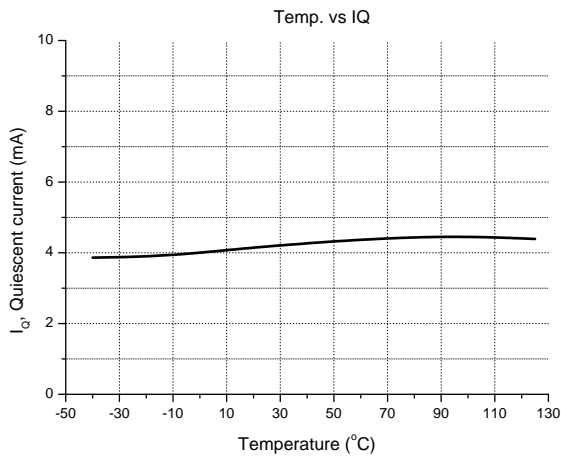
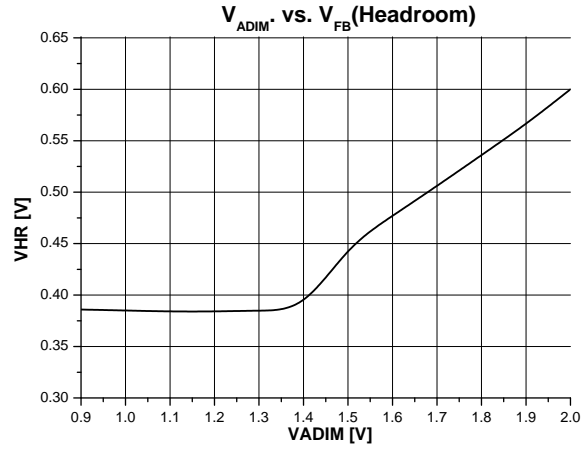
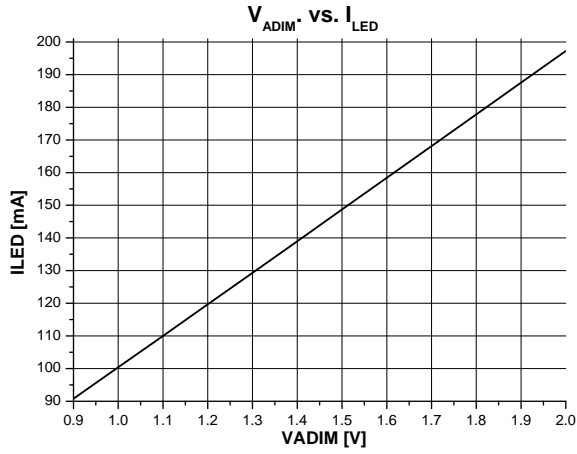

### Typical Operating Characteristics

Unless otherwise noted,  $V_{IN} = 12V$ ,  $C_{in}=220\mu F$ ,  $C_{out}=100\mu F$ ,  $R_{ISET}=5.5k\Omega$ ,  $R_{FSW}=250k\Omega$  and  $T_A = 25^\circ C$ .

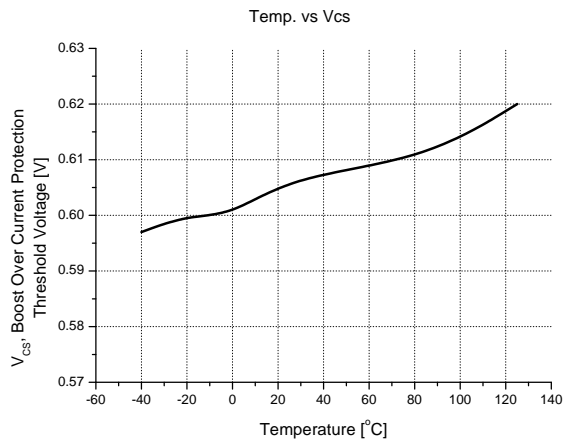
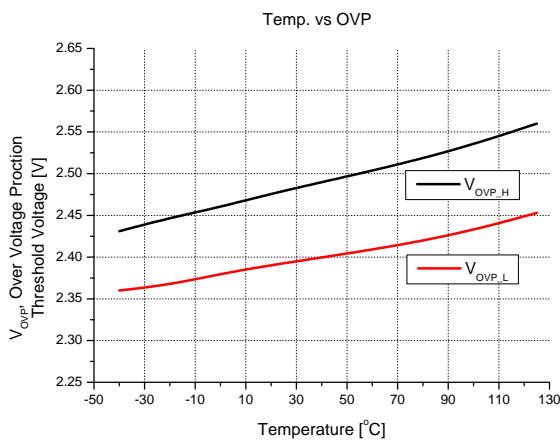
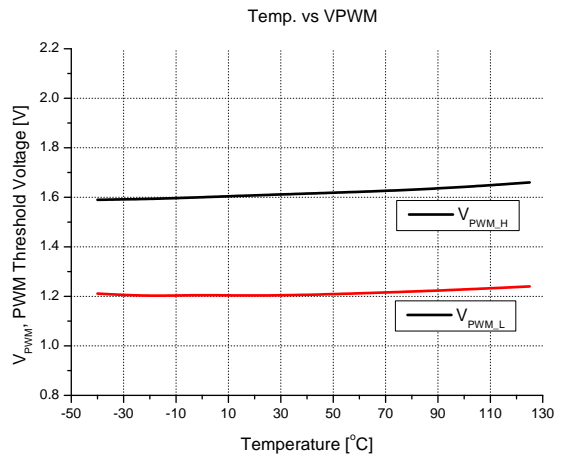
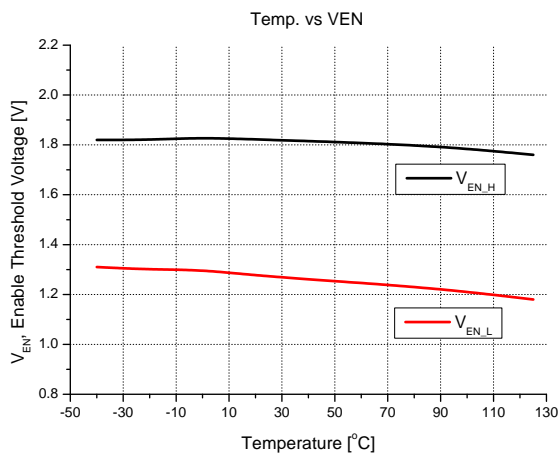
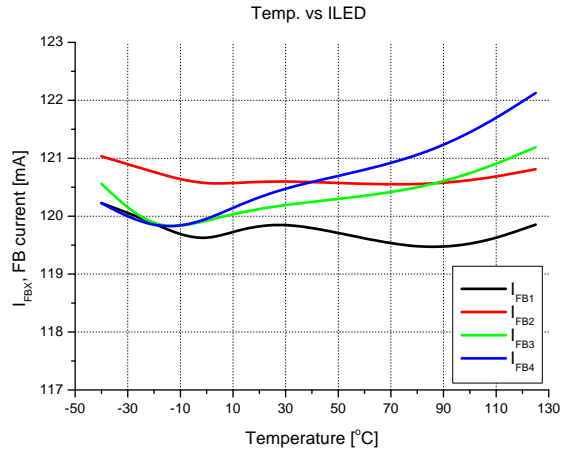
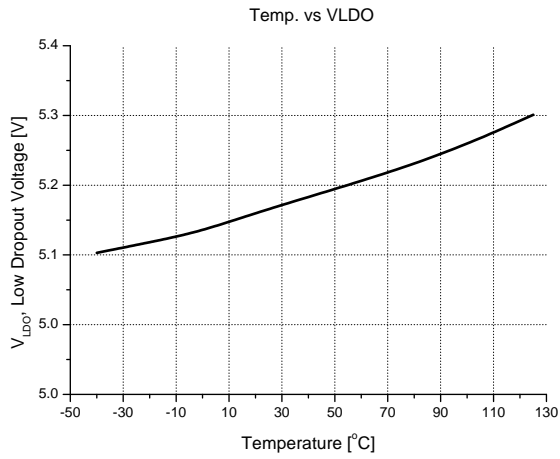

### Typical Operating Characteristics

Unless otherwise noted,  $V_{IN} = 12V$ ,  $C_{in}=220\mu F$ ,  $C_{out}=100\mu F$ ,  $R_{ISET}=5.5k\Omega$ ,  $R_{FSW}=250k\Omega$  and  $T_A = 25^\circ C$ .

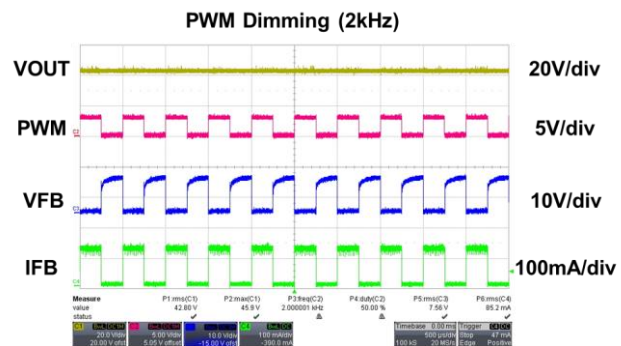
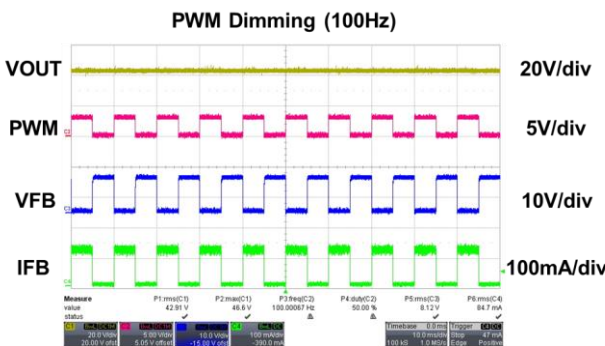
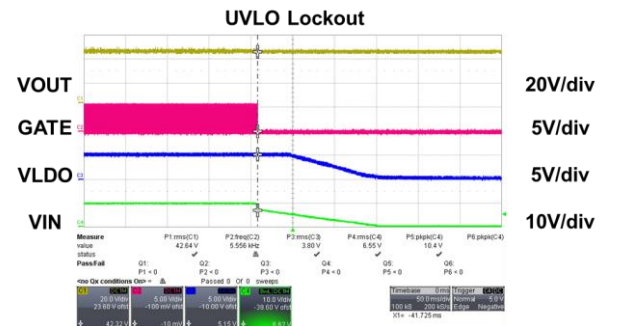
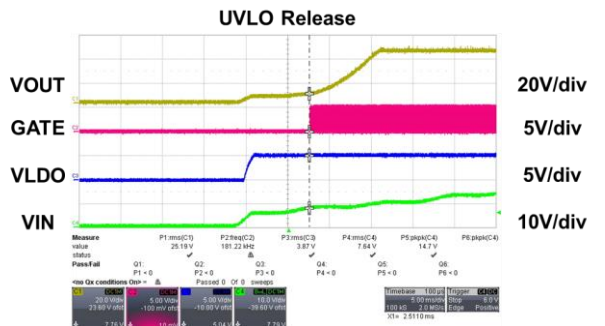
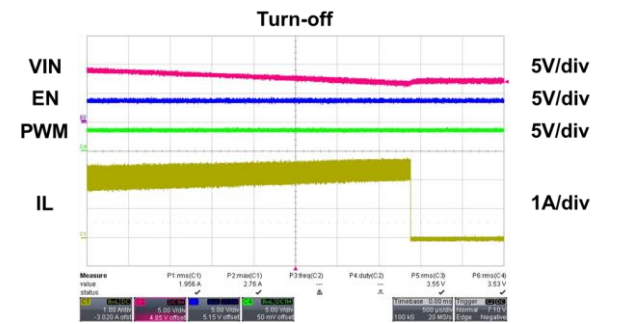
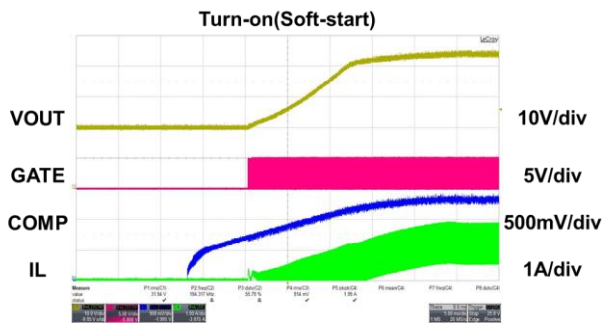
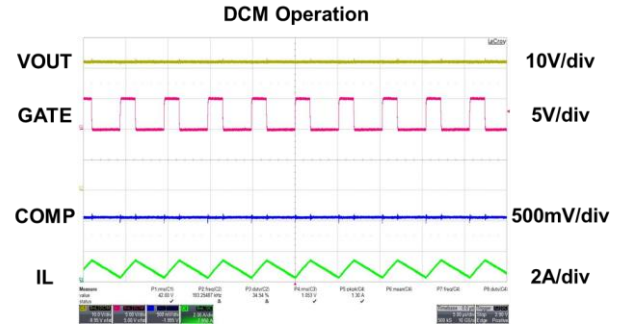
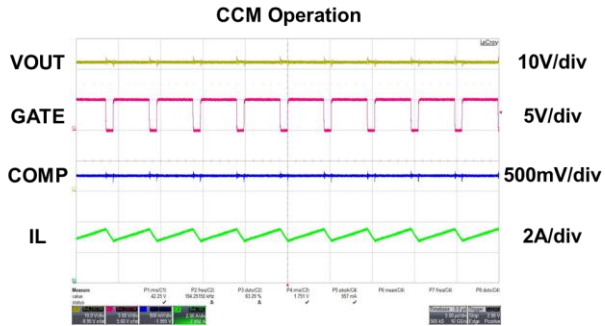



### Typical Operating Characteristics

Unless otherwise noted,  $V_{IN} = 12V$ ,  $C_{in} = 220\mu F$ ,  $C_{out} = 100\mu F$ ,  $R_{ISET} = 5.5k\Omega$ ,  $R_{FSW} = 250k\Omega$  and  $T_A = 25^\circ C$ .

Over-Voltage Protection(LED all open)

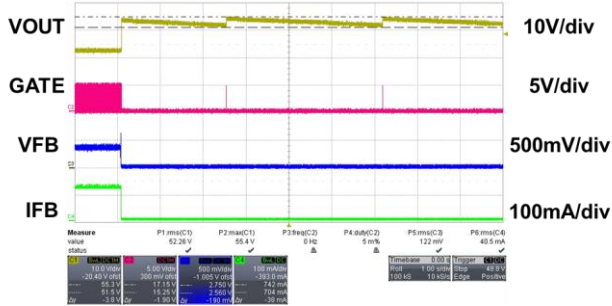

SBD Open Protection

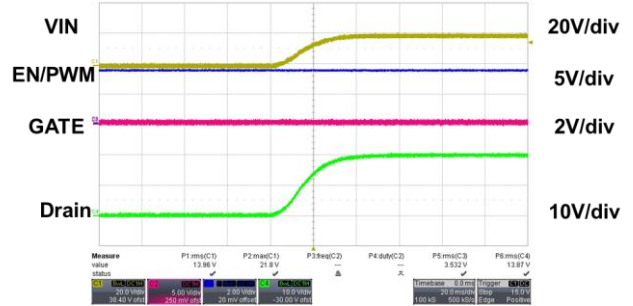

LED OPEN Protection

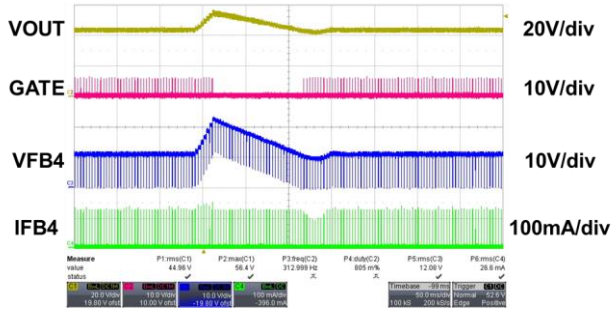

LED Short Protection

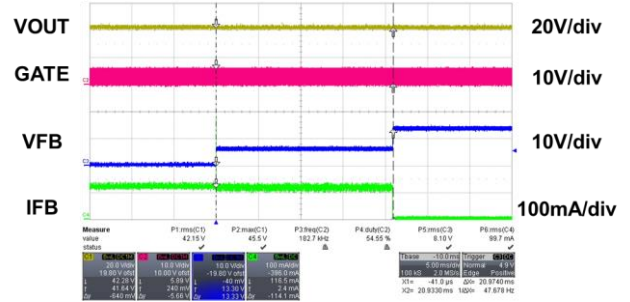

Thermal Shutdown

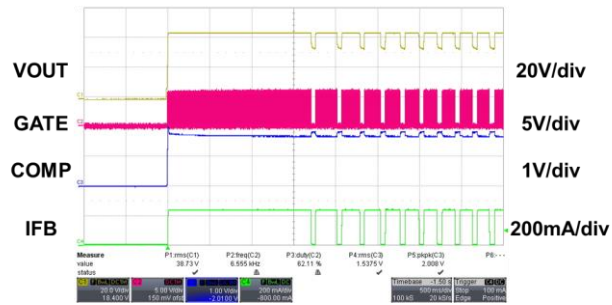

## Application Information

### CURRENT MODE BOOST SWITCHING CONTROLLER OPERATION

The MAP3249 employs current mode control boost architecture that has a fast current sense loop and a slow voltage feedback loop. Such architecture achieves a fast transient response that is essential for the LED backlight application.

### DYNAMIC HEADROOM CONTROL

The MAP3249 features a proprietary Dynamic Headroom Control circuit that detects the lowest voltage from any of the FB1-FB4 pins. This lowest channel voltage is used as the feedback signal for the boost controller. Since all LED stacks are connected in parallel to the same output voltage, the other FB pins will have a higher voltage, but the regulated current source circuit on each channel will ensure that each channel has the same current.

### INTERNAL 5.2V REGULATOR

The MAP3249 has built-in 5.2V LDO regulator to supply internal analog and logic blocks. The LDO is powered up when the EN pin is Logic High. A 2.2uF bypass capacitor is required on the VLDO pin for stable operation of the LDO.

### DIMMING SCHEME

The brightness control of the LEDs is performed by a pulse-width modulation of the channel current. When a PWM signal is applied to the PWM pin, the current generators are turned on and off mirroring the PWM pin behavior.

When PWM signal stays at low level (<0.8V), the MAP3249 turns off the boost circuitry, but internal circuit is enabled so the MAP3249 increases the output voltage promptly.

Min. PWM dimming on-time of MAP3249 is Max. 10us at 200kHz boost switching frequency. Thus, following table shows Min. PWM dimming duty-cycle at various PWM input frequency at 200kHz boost switching frequency.

fPWM [Hz]	Min. Duty-cycle
100	0.30%
200	0.40%
300	0.43%
400	0.48%
500	0.50%
1000	0.70%
1500	1.20%
2000	1.70%

### PARALLEL OPERATION

Even the MAP3249 has 4 channels and 200mA LED current capability per channel, 2 channels and 400mA application can be supported by tying 2FBs into 1ch, so the LED current capability can be increased to 400mA.

### LED CURRENT ADJUSTMENT

The MAP3249 sets the LED current through the voltage level on the ADIM pin. ADIM pin voltage vs. LED current is as following table.

The RISET/1% resistor must be connected between the ISET pin and ground.

RISET 5.5 kΩ	
ADIM Voltage [V]	LED Current [mA]
0.5	50
1.0	100
1.2	120
2.0	200

The relationship between ADIM pin voltage, RISET value and LED current is defined by following equation.

$$I_{LED}[mA] = \frac{V_{ADIM}[V]}{RISET[k\Omega]} * 550$$

The MAP3249 offers protection functions to limit excess LED current increase at abnormal ISET and ADIM pin voltage. If the ADIM or ISET pin voltage is at following conditions abnormally, the MAP3249 turns off the GATE output and internal LED current sink MOSFETs.

$$V_{ISET} \leq 0.3V$$

$$V_{ADIM} \geq 2.6V$$

### BOOST SWITCHING FREQUENCY

The switching frequency of the MAP3249 should be programmed between 100kHz and 500kHz by an external resistor connected between the FSW pin and ground. Do not leave this pin open. The approximate operating boost switching frequency can be calculated by following equation.

$$f_{SW}[MHz] = \frac{50}{R_{FSW}[k\Omega]}$$

If the FSW pin voltage is decreased to below or equal to 0.6V abnormally the MAP3249 turns off the GATE output to protect excess switching frequency increase.

**START-UP**

(1) The MAP3249 has soft-start circuitry internally and the soft-start time(tss) is typical 8.5ms.

(2) **‘Unused Channel Detection Function’**

There can be exist applications which do not use all the FB pins(4 channel). Conventional multi-channel LED drivers boost the output voltage to OVP level to check open FB(s).

The MAP3249 detects unused FB(s) and excludes corresponding FB(s) automatically from headroom control before start-up. **The unused FB(s) must be connected to GND.** This ensures the output voltage is not boosted to OVP level at start-up. If the unused FB(s) are not connected to GND, the output voltage is boosted up to OVP level like conventional boost LED driver.

These features significantly reduce the start-up current and prevent abnormal operation at start-up.

**OUTPUT OVER VOLTAGE PROTECTION**

To protect the boost converter when the load is open or the output voltage becomes excessive for any reason, the MAP3249 features a dedicated overvoltage feedback input. The OVP pin is connected to the center tap of a resistive voltage-divider from the high voltage output. When the OVP pin voltage exceeds typical 2.5V, a comparator turns off the external power MOSFET. This switch is re-enabled after the OVP pin voltage drops typical 100mV hysteresis below the protection threshold. This over voltage protection feature ensures the boost converter fail-safe operation when the LED channels are disconnected from the output.

A 5V zener diode is recommendable to avoid pin damage when the RVOPL resistor is open abnormally.

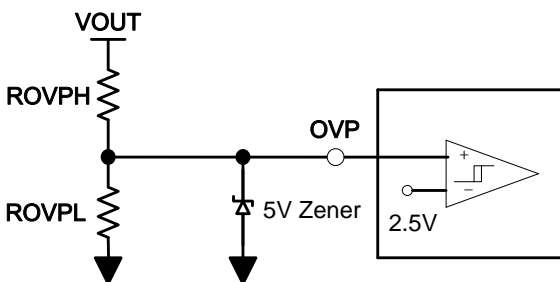

The OVP voltage of output voltage can be calculated by following equation.

$$V_{OUT\_OVP}[V] = 2.5 \times \left(1 + \frac{R_{OVPH}}{R_{OVPL}}\right)$$

**UNDER VOLTAGE LOCKOUT**

If the input voltage falls below the UVLO level of typical 6.5V on the VIN pin, the device will stop switching and be reset. Operation will restart when the VIN pin voltage rises to 7.5V. This ensures fail-safe operation when the input voltage falls below Min. VIN voltage of IC.

**SBD OPEN PROTECTION**

When OVP pin voltage is less than 0.1V, the MAP3249 turns off the GATE output.

This protects the driver from damage if the output schottky diode is open(defective or poor solder contact).

### BOOST OVER-CURRENT PROTECTION

The MAP3249 features Over-Current Protection (OCP) by sensing CS pin voltage. This CS pin is used for inductor current sensing for current mode control as well.

If the CS pin voltage exceeds typical 0.6V, the MAP3249 turns off the GATE output.

The internal OCP sensing voltage decreases with increase of gate duty-cycle due to internal slope compensation which ensures stable CCM operation.

Following graph shows the relationship between gate duty-cycle and internal OCP sensing typical voltage.

Vcs vs. Duty Cycle

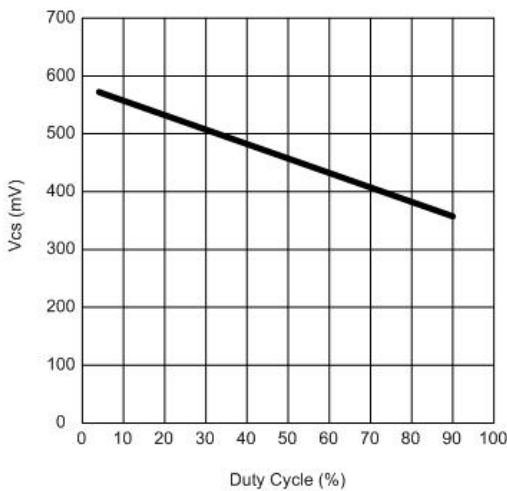

$$VCS\_OCP\_TYP.[V] = -0.21255D + 0.56125$$

#### RCS Setting Procedure

- (1) Choose boost inductor value

Once the LED current, the input and output voltage and the switching frequency are fixed, the inductance value defining the boundary between DCM and CCM operation can be calculated as;

$$L_B[H] = \frac{R_O \times D \times (1 - D)^2}{2 \times f_{SW}}$$

where, Ro=Vout/Iout

- (2) Find peak inductor current at selected boost inductance

$$I_{L\_peak\_DCM} = \frac{V_{IN} \times D_{(OVP)}}{f_{SW} \times L}$$

$$I_{L\_peak\_CCM} = I_{IN(OVP)} + \frac{V_{IN} \times D_{(OVP)}}{2f_{SW} \times L}$$

The RCS value should be chosen that the output voltage can be boosted up to OVP level. And the Iout value should be considered with Max. 3 channel because the OVP is occurred LED open event only. Thus,

$$I_{IN(OVP)}[A] = \frac{V_{OUT\_OVP} \times I_{LED/CH} \times (N_{FB} - 1)}{\eta \times V_{IN}}$$

$\eta$  : efficiency

$N_{FB}$  : The number of using channel

- (3) Find typical VCS\_OCP value at given D(OVP)

$$VCS\_OCP\_TYP.[V] = -0.21255 D_{(OVP)} + 0.56125$$

- (4) Find RCS value

In order to avoid touching the current limit during normal operation, the voltage across the current sensing resistor Rcs should be less than 80% of the worst case current limit voltage.

$$R_{CS}[\Omega] = 0.8 \times \frac{V_{CS\_OCP\_TYP}}{I_{L\_peak}}$$

#### Example

Vin=24V, Vout\_ovp=55V,  $\eta$ =90%, ILED/ch=100mA, LED string=4X16, fsw=200kHz

- (1) Choose boost inductor value

$$L_B = \frac{R_O \times D \times (1 - D)^2}{2 \times f_{SW}} = 37.5[\mu H]$$

In this case, chosen inductance value is 47uH for CCM operation.

- (2) Find peak inductor current

$$I_{IN(OVP)} = \frac{V_{OUT\_OVP} \times I_{LED/CH} \times (4 - 1)}{\eta \times V_{IN}} = 0.76[A]$$

$$I_{L\_peak\_CCM} = I_{IN(OVP)} + \frac{V_{IN} \times D_{(OVP)}}{2f_{SW} \times L} = 1.48[A]$$

- (3) Find typical VCS\_OCP value at given D(OVP)

$$VCS\_OCP\_TYP = -0.21255 D_{(OVP)} + 0.56125 = 0.441[V]$$

- (4) Find RCS value

$$R_{CS} = 0.8 \times \frac{V_{CS\_OCP\_TYP}}{I_{L\_peak}} = 0.24[\Omega]$$

MX provides ‘**Design spreadsheet for MAP3249**’ for ease external components calculation.

### LED OPEN PROTECTION

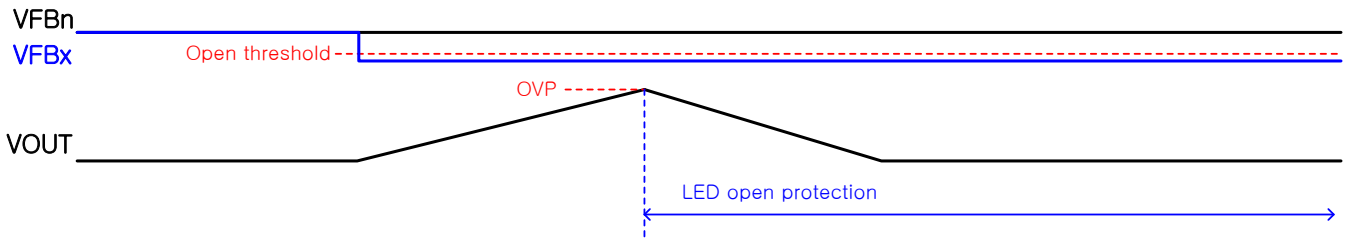

In case the voltage on any of LED current sink pins (FB1~4) is below LED open protection threshold due to LED open during normal operation, the output voltage is boosted up to 100% of OVP level and the MAP3249 automatically excludes the corresponding channel and remaining string(s) will continue operation.

### LED SHORT PROTECTION

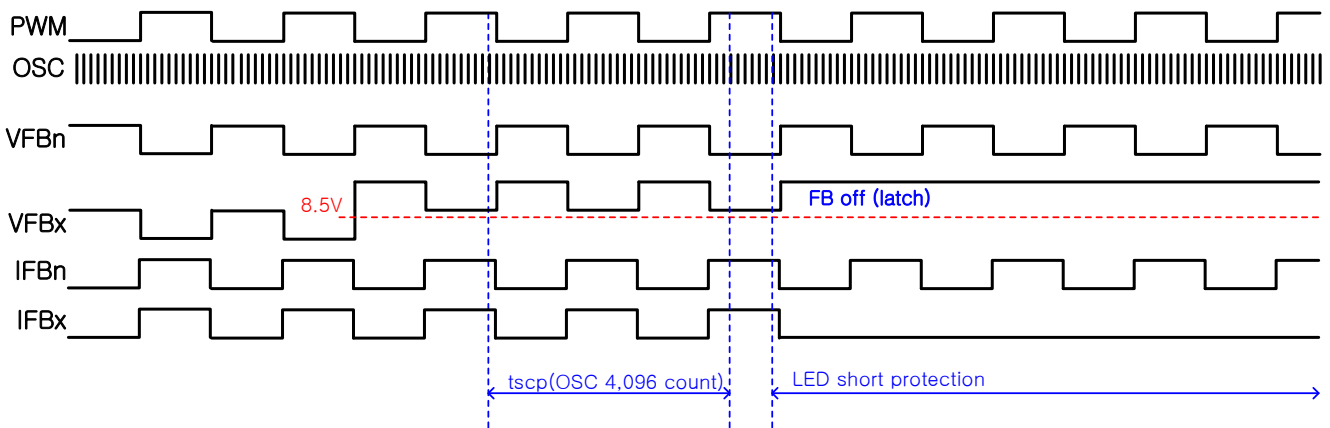

If the voltage at any of the FB1-4 pins exceeds LED short detection voltage(typ. 8.5V) due to LED short during normal operation and persists for tscp, the MAP3249 automatically turns off the corresponding channel and remaining channel(s) will continue operation.

The protection status is latched internally and can be cleared by recycling the EN pin or applying a complete power-on-reset(POR).

When LED(s) is(are) open on any channel, the output voltage is boosted up to OVP level and this can cause abnormal LED short protection due to high FB voltage. To avoid this abnormal operation, the MAP3249 disables the LED short protection function with related to Min. FB voltage conditions.

Min. VFB  $\geq$  2.60V => LED short protection disable

Min. VFB  $\leq$  2.15V => LED short protection enable

**OPERATION TIMING CHART**

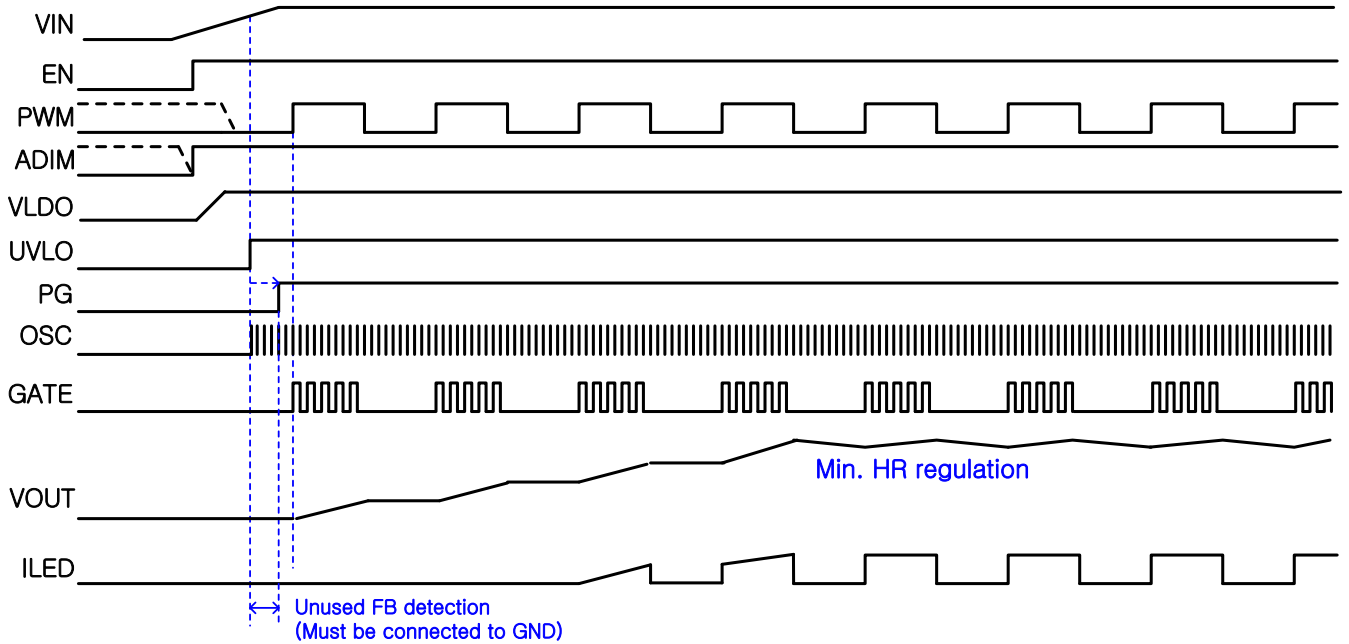

A capacitor on the VLDO pin begins charging after EN is turned-on. Once the VIN voltage reaches about 7.5V(See UVLO specification), the internal UVLO is released. The MAP3249 checks the initial open FB(s) and excludes corresponding FB(s) from headroom control before internal PG signal is set up. **The unused FB(s) must be connected to GND.** Internal controller starts boosting with first PWM input and performs soft-start. After soft-start is end or during soft-start period, the output voltage is boosted up to regulation voltage(total forward voltage of LED bar + FB Voltage) without touching OVP level and the controller performs headroom control.

The MAP3249 boosts the output voltage only in condition that VIN is applied and EN, PWM and ADIM is turned-on. And there is no limitation with regard to turn-on sequence. But in case that VIN(input voltage of booster) is applied lastly after EN, PWM and ADIM is turned-on, the start-up current is increased because the output voltage is boosted from 0V.

If the PWM signal remains logic low for over than 16.4ms( $1/f_{sw} * 8192$ ) at 500kHz boost switching frequency during normal operation, the controller regards it as dim-zero condition. Because of discharge of output capacitor through the OVP sensing resistors during the dim-zero time, the output voltage getting declined. The MAP3249 performs soft-start as soon as PWM signal rises to boost the output voltage rapidly.

The controller stops switching right after EN is turned-off.

## EXTERNAL COMPONENTS SELECTION

### Inductor

The inductor value should be decided before system design. Because the selection of the inductor affects the operating mode of CCM(Continuous Conduction Mode) or DCM(Discontinuous Conduction Mode).

The inductance value defining the boundary between DCM and CCM operation can be calculated as;

$$L_B[H] = \frac{R_O \times D \times (1-D)^2}{2 \times f_{SW}}$$

where,  $R_O = V_{out}/I_{out}$

In CCM operation, inductor size should be bigger, even though the ripple current and peak current of inductor can be small. In DCM operation, even ripple current and peak current of inductor should be large while the inductor size can be smaller.

The inductor DC current or input current can be calculated as following equations.

$$I_{IN}[A] = \frac{V_{OUT} \times I_{OUT}}{\eta \times V_{IN}}$$

$\eta$  – Efficiency of the boost converter

Then the duty ratio is,

$$D = \frac{V_{OUT} - V_{IN} + V_D}{V_{OUT} + V_D}$$

$V_D$  – Forward voltage drop of the output rectifying diode

When the boost converter runs in DCM ( $L < L_B$ ), it takes the advantages of small inductance and quick transient response. The inductor peak current is,

$$I_{L\_peak\_DCM} = \frac{V_{IN} \times D}{f_{SW} \times L}$$

The converter will work in CCM if  $L > L_B$ , generally the converter has higher efficiency under CCM and the inductor peak current is,

$$I_{L\_peak\_CCM} = I_{IN} + \frac{V_{IN} \times D}{2f_{SW} \times L}$$

### Boost MOSFET

The critical parameters for selection of a MOSFET are:

1. Maximum drain current rating,  $I_{D(MAX)}$
2. Maximum drain to source voltage,  $V_{DS(MAX)}$
3. On-resistance,  $R_{DS(ON)}$
4. Gate source charge  $Q_{GS}$  and gate drain charge  $Q_{GD}$
5. Total gate charge,  $Q_G$

The maximum current through the power MOSFET happens when the input voltage is minimum and the output power is maximum. The maximum RMS current through the MOSFET is given by;

$$I_{RMS(MAX)} = I_{IN(MAX)} \times \sqrt{D_{MAX}}$$

The off-state voltage of the MOSFET is approximately equal to the output voltage plus the diode  $V_f$ . Therefore,  $V_{DS(MAX)}$  of the MOSFET must be rated higher than the maximum output voltage(OVP voltage).

The power losses in the MOSFET can be separated into conduction losses and switching losses. The conduction loss,  $P_{cond}$ , is the  $I^2R$  loss across the MOSFET. The conduction loss is given by;

$$P_{COND} = R_{DS(ON)} \times I_{RMS}^2 \times k$$

where  $k$  is the temperature coefficient of the MOSFET.

The switching loss is related to  $Q_{GD}$  and  $Q_{GS1}$  which determine the commutation time.  $Q_{GS1}$  is the charge between the threshold voltage and the plateau voltage when a driver charges the gate, which can be read in the chart of  $V_{GS}$  vs.  $Q_G$  of the MOSFET datasheet.  $Q_{GD}$  is the charge during the plateau voltage. These two parameters are needed to estimate the turn on and turn off loss.

$$P_{SW} = \frac{Q_{GS1} \times R_G}{V_{DR} - V_{TH}} \times V_{DS} \times I_{IN} \times f_{SW} + \frac{Q_{GD} \times R_G}{V_{DR} - V_{PLT}} \times V_{DS} \times I_{IN} \times f_{SW}$$

where  $V_{TH}$  is the threshold voltage,  $V_{PLT}$  is the plateau voltage,  $R_G$  is the gate resistance,  $V_{DS}$  is the drain-source voltage,  $V_{DR}$  is the drive voltage

The total gate charge,  $Q_G$ , is used to calculate the gate drive loss. The expression is

$$P_{DR} = Q_G \times V_{DR} \times f_{SW}$$

Fast switching MOSFETs can cause noise spikes which may affect performance. To reduce these spikes a drive resistor can be placed between GATE pin and the MOSFET gate.



**Output Rectifying Diode**

Schottky diodes are the ideal choice for MAP3249 due to their low forward voltage drop and fast switching speed. Make sure that the diode has a voltage rating greater than the possible maximum output voltage. The diode conducts current only when the power switch is turned off.

**Input Capacitor**

In boost converter, input current flows continuously into the inductor; AC ripple component is only proportional to the rate of the inductor charging, thus, smaller value input capacitors may be used. Ensure the voltage rating of the input capacitor is suitable to handle the full supply range.

A capacitor with low ESR should be chosen to minimize heating effects and improve system efficiency.

**Output Capacitor**

The output capacitor acts to smooth the output voltage and supplies load current directly during the conduction phase of the power switch. Output ripple voltage consists of the discharge of the output capacitor during the FET ton period and the voltage drop due to load current flowing through the ESR of the output capacitor. The ripple voltage is shown in following equation.

$$\Delta V_{OUT} = \frac{I_{OUT} \times D}{C_{OUT} \times f_{SW}} + I_{OUT} \times ESR$$

Assume a ceramic capacitor is used. The minimum capacitance needed for a given ripple can be estimated by following equation.

$$C_{OUT} = \frac{(V_{IN} - V_{OUT}) \times I_{OUT}}{V_{OUT} \times f_{SW} \times \Delta V_{OUT}}$$

**Loop Compensation**

The MAP3249 controls in current mode. Current mode easily achieves compensation by consisting simple single pole from double pole that LC filter makes at voltage mode. In general, crossover frequency is selected from 1/3 ~ 1/6 range of the switching frequency. If fc is large, there is possibility of oscillation to occur, although time response gets better.

On the other hand, if fc is small, time response will be bad, while it has improved stability, which may cause over shoot or under shoot in abnormal condition.

**Layout Consideration**

A gate drive signal output from GATE pin becomes noise source, which may cause malfunction of IC due to cross talk if placed by the side of an analog line. It is recommended to avoid placing the output line especially by the side of CS, ADIM, ISET, FSW, OVP, COMP pins as far as possible.

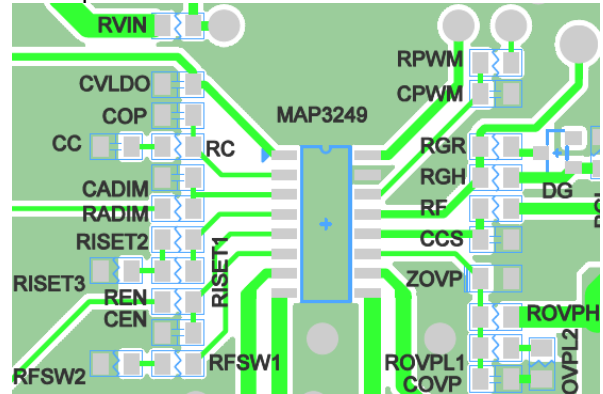

**Thermal Consideration**

For continuous operation, do not exceed absolute maximum junction temperature. The maximum power dissipation depends on the thermal resistance of the IC package, PCB layout, rate of surrounding airflow, and difference between junction and ambient temperature. The maximum power dissipation can be calculated by the following formula:

$$Pd_{(MAX)} = \frac{T_{J(MAX)} - T_A}{\theta_{JA}}$$

where T<sub>J(MAX)</sub> is the maximum junction temperature, T<sub>A</sub> is the ambient temperature, and θ<sub>JA</sub> is the junction to ambient thermal resistance.

The maximum power dissipation depends on the operating ambient temperature for fixed T<sub>J(MAX)</sub> and thermal resistance, θ<sub>JA</sub>. For the MAP3249 packages, the derating curve in following graph allows the designer to see the effect of rising ambient temperature on the maximum power dissipation.

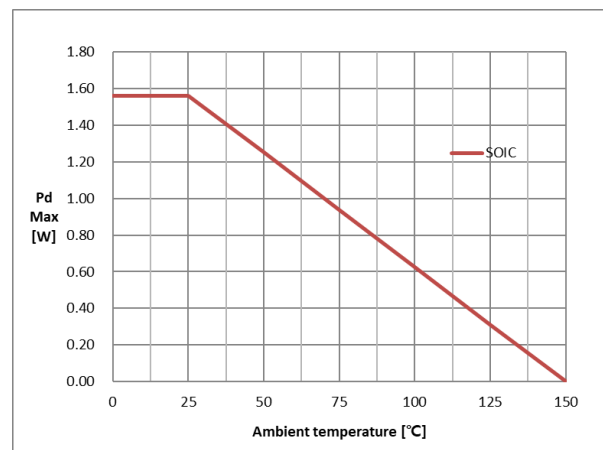



For a typical application, the operation power of the IC can be calculated roughly by;

$$P_d = (V_{IN} \cdot I_{IN}) + (V_{FB1} \cdot I_{FB1} + \square\square\square + V_{FB4} \cdot I_{FB4}) \cdot D_{PWM}$$

where  $V_{IN}$  represents the input voltage at the VIN pin of the IC and  $I_{IN}$  represents the current flow into the VIN pin of the IC.  $D_{PWM}$  is duty cycle of PWM input signal.

Physical Dimensions

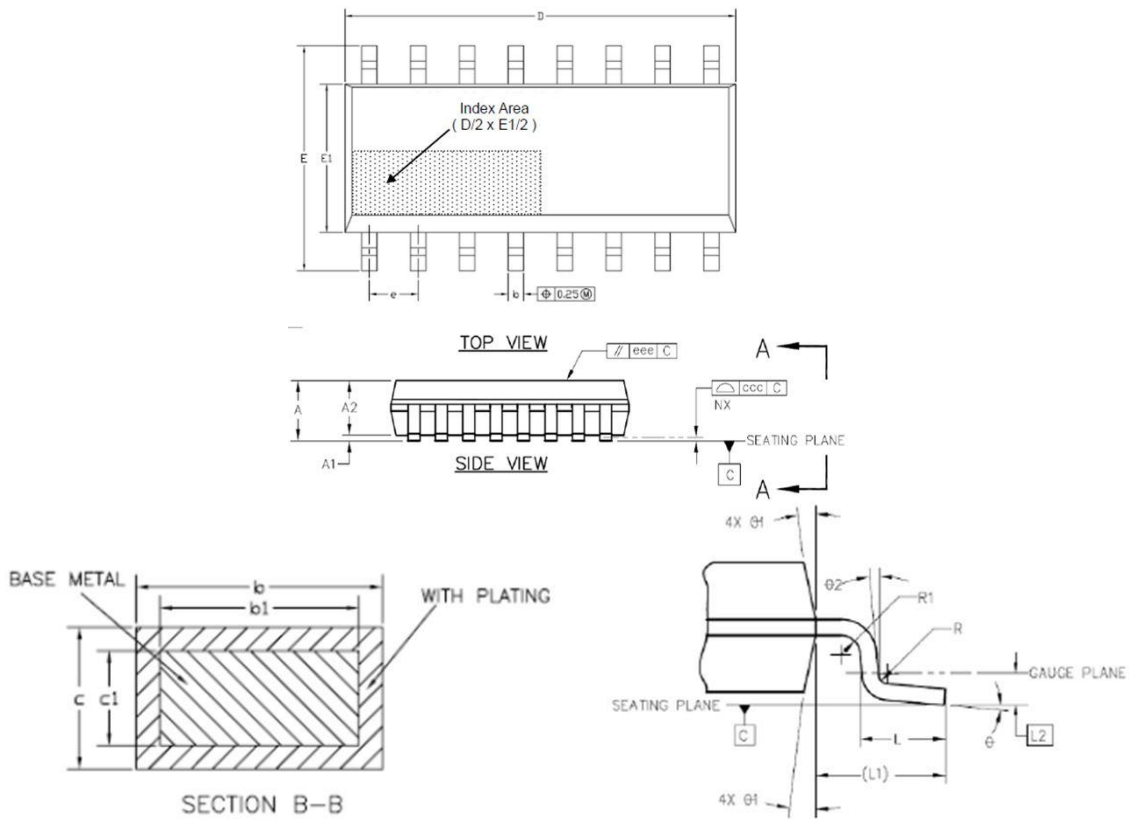

16 Leads SOIC

Symbol	Min	Nom	Max
A	-	-	1.80
A1	0.05	-	0.25
A2	1.25	-	-
b	0.31	-	0.51
b1	0.28	-	0.48
C	0.10	-	0.30
c1	0.10	-	0.23
D	9.70	-	10.10
E	5.70	-	6.30
E1	3.75	-	4.15
e	1.14	1.27	1.40
L	0.40	-	1.27
L1	1.04 REF		
L2	0.25 BSC		
R	0.07	-	-
R1	0.07	-	-
θ	0°	-	8°
θ1	0°	-	15°

Magnachip Semiconductor Ltd. doesn't not recommend the use of its products in hostile environments, including, without limitation, aircraft, nuclear power generation, medical appliances, and devices or systems in which malfunction of any product can reasonably be expected to result in a personal injury. Seller's customers using or selling Seller's products for use in such applications do so at their own risk and agree to fully defend and indemnify Seller.

Magnachip reserves the right to change the specifications and circuitry without notice at any time. Magnachip does not consider responsibility for use of any circuitry other than circuitry entirely included in a Magnachip product.

 Magnachip is a registered trademark of Magnachip Semiconductor Ltd.